

PADS No. 087/000662
Weatherproof Telephone RA711-3B

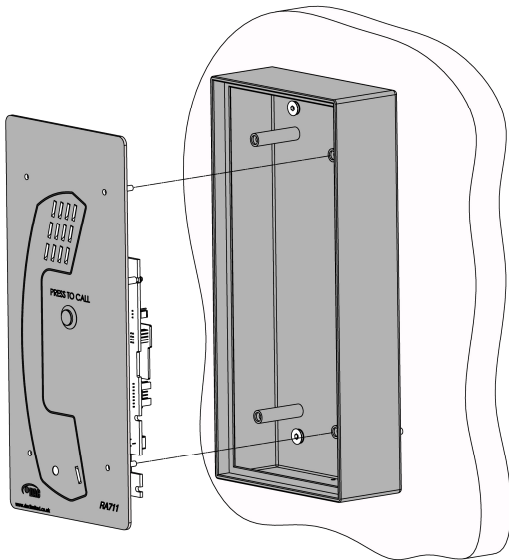

- RA711 Series
- Network Rail acceptance
- 3 Autodial Buttons
- Auto Clear Down
- Non-volatile memory
- LED Indicator for off-hook
- Raised buttons in line with DD A directives
- All weather protection
- Simple installation
- Fast-fit terminal connection
- Various mounting options
- REN-1 rating
- Line powered
- CE compliant

Mounting options:



Top of pole mounting:

Top of Pole bracket available from DAC:

Part No. 503483

PADS No. 087/000667

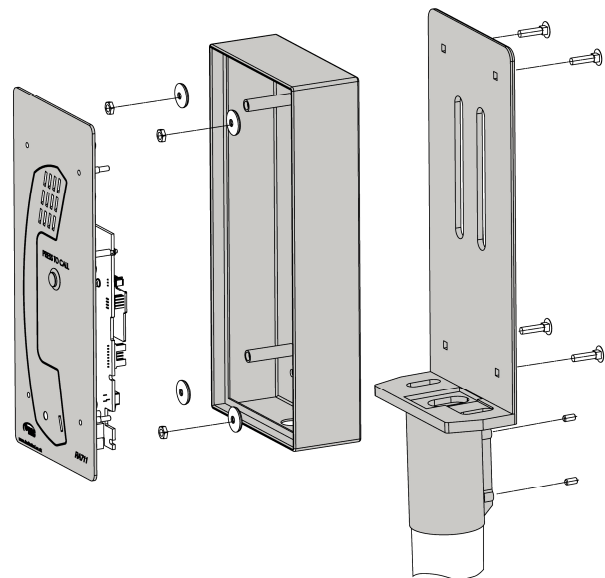

Wall mounting:

On Wall box available from DAC:

Part No. RA711-NR

PADS No. 087/000666

DAC Limited
Union Mill, Watt Street,
Sabden, United Kingdom
BB7 9ED,

Tel. +44 (0) 1282 447000, Fax: +44 (0) 845 280 1915
www.daclimited.co.uk

TECHNICAL SPECIFICATION

Speech/ Network Interface:

Voice switched (VOX) semi duplex operation.

Ringling:

Through internal speaker, REN 1,

Power Supply:

Line powered, 15mA min.

Call Cleardown/Time out:

Adjustable timer from 1 to 10 minutes or off.
Auto cleardown function on tone detection from the line

Temperature:

Operating: -30° C to +60° C
Storing: -40° C to +70° C

Relative Humidity:

Up to 95% (non-condensing)

Keypad/Buttons:

Heavy duty metal keypad and buttons, Vandal resistant.

Material:

Robust high grade Stainless Steel

Programming:

Using on board keypad and externally connected security keypad

Weight:

1.8kg

Safety:

Manufactured to BS EN 60950

Protection:

Dust and Liquids to BS 5490: 1977 IP55

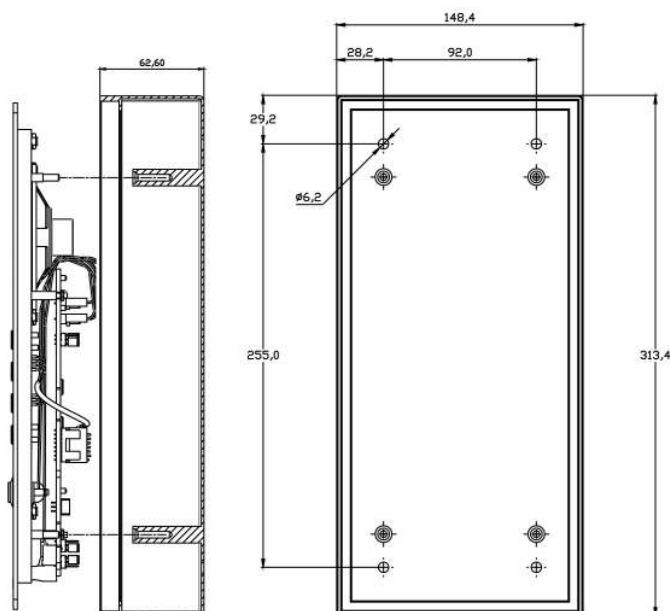
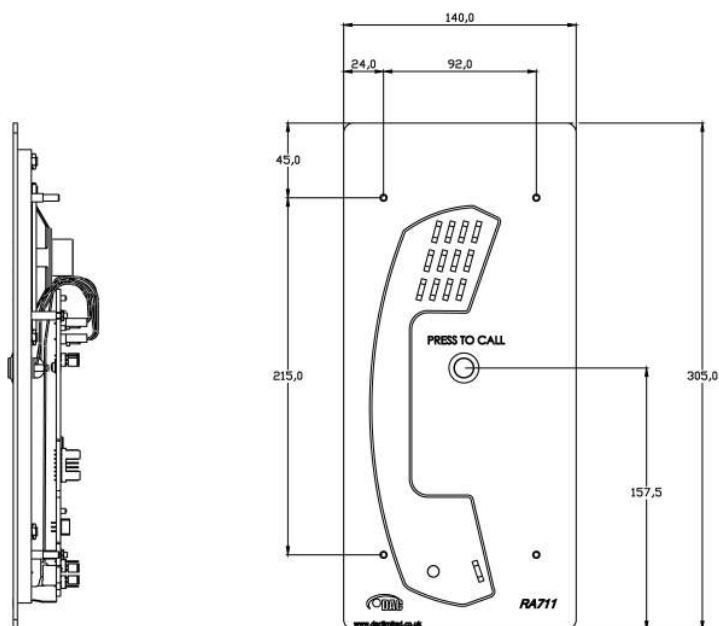

DAC Limited
Union Mill, Watt Street,
Sabden, United Kingdom
BB7 9ED,

Tel. +44 (0) 1282 447000, Fax: +44 (0) 845 280 1915
www.daclimited.co.uk